



Flush-mount LCD  
multimeters.  
expandable  
DMG900  
Three-phase +  
neutral

Product designation

Product type designation

Type

**Auxiliary supply Us**

Auxiliary rated supply voltage AC	VAC	100...440
Auxiliary rated supply voltage DC	VDC	110...250
Auxiliary operating voltage range		
AC	min VAC	90
	Max VAC	484
DC	min VDC	93.5
	Max VDC	300

Operational frequency	min Hz	45
	max Hz	66

Power consumption	Max VA	3.9
-------------------	--------	-----

Power dissipation Max	W	3.4
-----------------------	---	-----

**Measuring voltage inputs**

Rated voltage (Ue)	phase-phase VAC	690
	phase-neutral VAC	400

Operating voltage range	phase-phase VAC	20...830
	phase-neutral VAC	10...480

Voltage inputs operational frequency	min Hz	45 and 360
	max Hz	66 and 440

Voltage inputs measurement method	True RMS
-----------------------------------	----------

Connection method	Single, two, three-phase with or without neutral, balanced three-phase system
-------------------	---

**Current inputs**

Rated current (Ie)	A	1A/5A
--------------------	---	-------

Measurement range	0.002...1.2 / 0.01...10
-------------------	-------------------------

Measurement method	TRMS
--------------------	------

Overload capacity	+20% Ie by external CT with 5A secondary
-------------------	--

Overload peak		A	50A for 1s
<b>Accuracy</b>			
	VLN voltage		±0.2%
	VLL voltage		±0.2%
	Current		±0.2%
	Frequency		±0.05%
	Active power		±0.5% f.s.
	Active energy		Class 0.5s (IEC/EN 62053-22)
	Reactive energy		Class 2 (IEC/EN 62053-23)
<b>Insulations</b>			
Rated insulation voltage Ui IEC/EN		V	690
Rated impulse withstand voltage Uimp		kV	9.5
Operating frequency withstand voltage		kV	5.2
<b>Mechanical features</b>			
Housing type			Polyamide
Terminals type			Removable
Conductor cross section			
	min	mm <sup>2</sup>	0.2
	Max	mm <sup>2</sup>	2.5
	min	AWG	24
	Max	AWG	12
Tightening torque (Max)			
		Nm	0.5
		lbin	4.5
Fixing			Flush-mounting
Weight		g	566
<b>Ambient conditions</b>			
Temperature			
	Operating temperature		
		min	°C -20
		max	°C +60
	Storage temperature		
		min	°C -30
		max	°C +80
Relative humidity		%	<90
Maximum Pollution degree			2
Protection degree			IP65
<b>Dimensions [mm (in)]</b>			

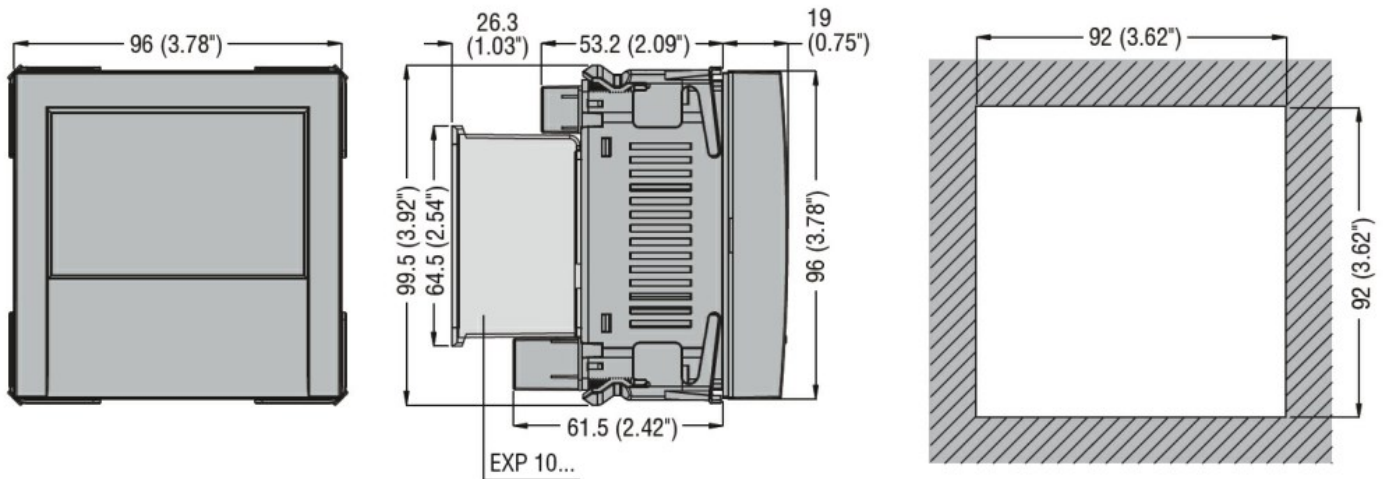

**Wiring diagrams**

Single-phase

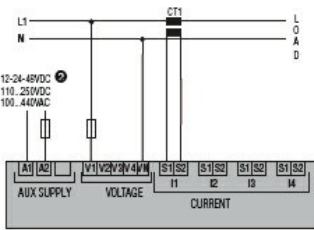

Two-phase

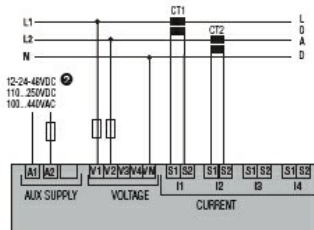

Three-phase with or without neutral

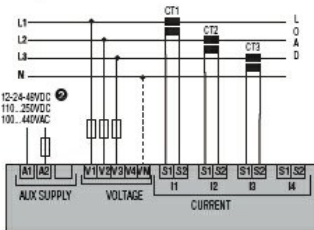

Three-phase without neutral in ARON connection

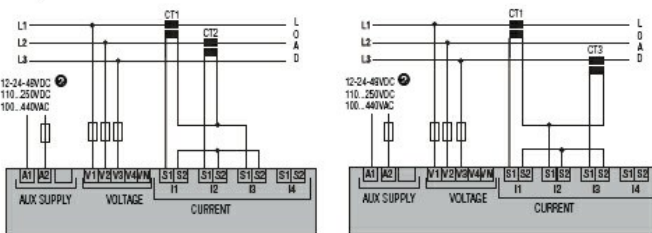

Two-phase with neutral. Measurement of neutral current and neutral-earth voltage

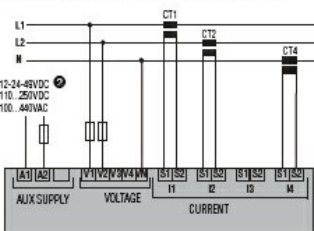

Three-phase with neutral. Measurement of neutral current and neutral-earth voltage

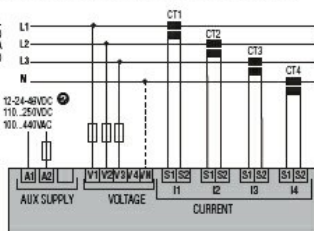

⊕ For DMG 900... D048 only.

**Certifications and compliance**

Compliance

CSA C22.2 n°14  
IEC/EN 61000-6-2

---

IEC/EN 61000-6-4

---

IEC/EN 61010-1

---

UL508

Certificates

---

cULus

---

EAC

---

GOST

---

RCM

ETIM classification

ETIM 8.0

EC002301 -  
Multifunction  
measuring  
instrument